

PURCHASE ORDER ITEMS FOR ACCOUNTS PAYABLE  
 03/08/16  
 PO NUMBER P215651

PO DATE 02/11/16      APPROVED

VENDOR 25858      ADDR # 0      FLEET MANAGEMENT MAIN GARAGE  
 KASSBOHRER ALL TERRAIN VEHICLES, INC.      CITY OF HOLLYWOOD  
 8850 DOUBLE DIAMOND PARKWAY      1602 S. PARK ROAD  
 RENO NV 89521      HOLLYWOOD FL 33021  
 954 967-4555

ENCUMBERED DATE 02/11/16      ORDER TOTAL 109768.00  
 FOB      TERMS

LINE REQ #	TRANS #	UOM	TYPE	WHSE	STOCK #	BPO #	PRICE	ACCOUNT #	ITEM TOTAL
1	R237464	EA			12979 N		1.0000	109768.00000	57.5100.14106.590.056452
	Y	020416							109768.00
DESCRIPTION: SUPPLY & DELIVERY OF ONE (1) 2016 BEACH TECH MARINA UNIT									
PATENTED RAKING/SCREENING SYSTEM FOR DRY/WET SAND									
POLYETHYLENE FINISHING COMB W/HYDRAULIC LIFTING MECHANISM									
GALVANIZED COMPONENTS W/TWO PART ACRYLIC PAINT FINISH									
STAINLESS STEEL HYDRAULIC PIPES & NICKEL CHROME HYDRAULIC CYLINDER RODS									
REVERSE VALVE TO CHANGE SCREENING BELT DIRECTION									
TENSION ROLLER FOR SCREEN MESH									
1-NICKEL, DIME OR QUARTER SIZE HIGH-TENSION STEEL CLEANING BELT									
HIGH FLOTATION 520MM/20.5" TIRES									
WORKING BEACH CLEANING WIDTH OF 55", MAXIMUM DEPTH OF 6"									
.7 CUBIC YARD COLLECTOR BIN W/DISCHARGE HEIGHT OF 5' 4"									
3 FT HITCH WITH HYDRAULIC									

PURCHASE ORDER ITEMS FOR ACCOUNTS PAYABLE  
03/08/16  
PO NUMBER P215651

COUPLINGS FOR FRONT END ATTACHMENTS

2 EXTRA SET OF TINES

AIR CONDITIONING SYSTEM, FACTORY  
INSTALLED

ALL TRAINING FOR OPERATORS &  
MECHANICS IS INCLUDED.

A FULL ONE YEAR WARRANTY

MAINTENANCE FREE BEARINGS ON ALL  
ROLLERS, GUARANTEED FOR FIVE YEARS.

DATE OF QUOTE: 02/04/16  
QUOTE IS VALID THROUGH APRIL 16,  
2016

ADVERTISING: NO EMBLEM, LOG, TAG  
OR OTHER DEVICE OR DESIGN  
PROMOTING THE DEALER MAY BE  
AFFIXED IN ANY MANNER TO ANY  
VEHICLE DELIVERED UNDER THIS  
CONTRACT, EXCEPT FOR EMBLEMS  
INSTALLED BY MANUFACTURER  
IDENTIFYING MANUFACTURER AND  
MODEL.

ATTENTION: PRIOR TO FINAL PAYMENT  
BY THE CITY, THE VENDOR SHALL  
PROVIDE THE CITY WITH THE  
MANUFACTURERS STATEMENT OR  
CERTIFICATE OF ORIGIN, LISTING THE  
CITY OF HOLLYWOOD

NOTE: CONFIRMATION OF THE VENDOR  
ORDER PLACEMENT MUST BE RECEIVED  
BY THE CITY OF HOLLYWOOD WITHIN  
FOURTEEN (14) CALENDAR DAYS AFTER  
RECEIPT OF THE CITY'S PURCHASE  
ORDER.

RESOLUTION #R-2016-XXX  
DATED: FEBRUARY XX, 2016



1

## Notice of Intent to Award a Sole-Source Procurement

**Date:** March 9, 2016

**NTSS-024-16**

**Due Date for Comments:** March 16, 2016

**E-mail Address:** [rdierks@hollywoodfl.org](mailto:rdierks@hollywoodfl.org)

**Fax Number:** 954-921-3086

### THIS IS NOT A COMPETITIVE BID

The proposed contract action is for product or services for which the City of Hollywood intends to negotiate and award with only one source under the authority of the City of Hollywood City Code Section 38.40 (C) (3) Sole-source supplies and services. Any responses received as a result of this Notice of Intent shall be considered solely for the purpose of determining whether to conduct a competitive procurement in the future. Responses will not be considered as proposals, bids, or quotes.

The Procurement Services Division has received a request to make the following sole-source procurement:

**Requesting Department/Office:** Public Works

**Product and/or services to be purchased:** One (1) 2016 BeachTech Marina Model Beach Cleaner

**Anticipated Cost:** \$109,768.00

**Sole Source Justification:** The BeachTech Marina is a unique machine built with special features to allow the operator to perform several functions at once, thus minimizing additional cleaning processes with other machinery and reducing time spent with the beach cleaning process. Kassbohrer All Terrain, Inc. is the only company in the work that manufactures this type of beach cleaning machine. Other companies with beach cleaning machines do not have any comparable type of equipment as the BeachTech Marina.

#### Action To Be Taken:

No action is required if you agree this proposed purchase is a valid sole-source. If you do not agree that this proposed purchase is a sole-source, you may respond by submitting in writing their name, address, point of contact, telephone number, email, and a statement regarding capability to provide the specified procurement. Interested firms will be considered only if they respond with clear and convincing documentation that they are capable of meeting or exceeding the requirements stated herein. All responses received within five (5) business days after the date of publication of this synopsis will be reviewed by the City.

All responses must be in writing and returned to ATTN: Ralph Dierks or Facsimile number 954-921-3086 prior to the "Due Date for Comments." Please do not submit a bid for this public posting.

Procurement Services Division  
2600 Hollywood Boulevard, Room 303  
Hollywood, Florida 33020



# CITY OF HOLLYWOOD, FLORIDA

## PROCUREMENT SERVICES DIVISION

### Sole Source Justification Form (Use for Purchases(s) in excess of \$2,500)

Per City of Hollywood Ordinance § 38.40 (C) (3) 'sole source' purchases are exempt from the competitive bid and competitive proposal requirements. *Sole-source supplies and services, such as unique, patented, or franchised supplies or services, are exempt if the Director of Procurement Services determines, after a good faith review of available sources, that a particular supply or service is available from only one source.*

2016 FEB 16 PM 10:20  
CITY OF HOLLYWOOD  
PROCUREMENT SERVICES  
DIVISION

Date : 02/05/2016

Department/Office : Public Works

Division/Area : 5101

Contact Person Joel Wall; Sylvia Glazer

Title : Fleet Coordinator; Sylvia Glazer

Phone 954-967-4555; 4526

Email : jwall@hollywoodfl.org;  
sglazer@hollywoodfl.org

1. Requested Vendor : Kassbohrer All Terrain

Vendor Number : 25858

Address : 8850 Double Diamond Pkwy., Reno, NV. 89521

Contact Person : Evan Huckaby

Title : Utility Sales Representative

Phone : 775-848-8258

Email : ehuckaby@pistenbullyusa.com

2. Product/Service being requested (be specific). : (1) 2016 Beach Tech Marina

3. Detailed description of the product/service function and purpose. : Beach Maintenance is requesting a 2016 Beach Tech Marina for sifting litter and seaweed, and grooming of the beach. Beach Tech is the only company that builds this self-propelled beach cleaning machine that will enable the operator to rake and sift the beach sand wet or dry at the same time. This machine articulates in the middle for close turns around trees, life guard stands, walls and other obstacles, and is designed with extra wide flotation tires for low ground pressure (minimal foot imprint). The sifting screen can be customized to fit the City of Hollywood's beach applications. This beach cleaning machine is necessary for the successful operation of Beach Maintenance to ensure cleanliness and avoidance of any safety issues for the residences, tourists and visitors.

4. Please explain in detail why this vendor is the sole source supplier for the required product/service. Be sure to explain the necessary features this vendor provides which are not available from any other vendor.

*Procurement Service Division use only*

Requisition # R \_\_\_\_\_  
(As Applicable)

Purchase Order # P 215651  
(As Applicable)

Blanket Purchase Order # BPO \_\_\_\_\_  
(As Applicable)

The Beach Tech Marina is a unique machine built with special features to allow the operator to perform several functions at once, thus minimizing additional cleaning processes with other machinery and reducing time spent with the beach cleaning process. Kassbohrer All Terrain Inc. is the only company in the world that manufactures this type of beach cleaning machine.

5. Please explain in detail what process the Department/Office took to verify that there are no other vendors or products/services available to perform the required function.

Other companies with beach cleaning machines do not have any comparable type of equipment as the Beach Tech Marina.

6. Please submit supporting documentation from the vendor or other sources certifying that this vendor is a sole source for the required product/service being requested. For example, the vendor holds the distribution rights, productions rights, copyrights, trademark and/or patent:

Vendor holds the exclusive rights for the product/service.

Vendor is the sole provider of the product/service that has unique characteristics essential to the needs which no other product is capable.

Product is replacing existing product and necessary to maintain warranty or service contract.

Product is replacing existing product and is not interchangeable with any other product.

7. Total cost of the requested product/service? : \$109,768.00

8. Total estimated annual (fiscal year) cost of requested product/service? : \$109,768.00

Account Number(s) 57.5100.14106.590.056452 \_\_\_\_\_

9. Is this product/service covered by a warranty?  Yes  No

If yes, please attach a copy of the warranty details.

10. Would this purchase(s) result in the potential of future purchases for related products/services being restricted to a particular vendor or create a specific vendor as sole source provider for related items?

Yes  No

If yes, please describe the related products/services and estimated cost(s.)  
\_\_\_\_\_

11. Would this purchase(s) result in any future maintenance costs which are not included in the initial purchase?

Yes  No

If yes, please attach a draft maintenance plan which includes cost estimates and funding source(s.)  
\_\_\_\_\_

12. Is this a grant related purchase?  Yes  No

If yes, please provide details (timeline, expiration dates, milestones, special procurement requirements, etc.) \_\_\_\_\_

*Procurement Service Division use only*

Requisition # R \_\_\_\_\_  
(As Applicable)

Purchase Order # P 215651  
(As Applicable)

Blanket Purchase Order # BPO \_\_\_\_\_  
(As Applicable)

Will this require matching funds?  Yes  No

What is the grant source? \_\_\_\_\_

What is the grant (dollar) amount? \_\_\_\_\_

13. Please complete an advanced search of the vendor recommended for award on the Federal Government's Systems for Award Management at [www.sam.gov](http://www.sam.gov).

Date of Advanced Search 3/8/16

Company Name(s) Searched KASSADHOOR ALL TERRAIN VEHICLES INC Search Results N/A

\_\_\_\_\_

\_\_\_\_\_

\_\_\_\_\_

\_\_\_\_\_

\_\_\_\_\_

\_\_\_\_\_

### REQUESTING DEPARTMENT RECOMMENDATION

**WARNING:** Per Florida Statutes 838.22(2) – "It is unlawful for a public servant, with corrupt intent to obtain a benefit for any person or to cause unlawful harm to another, to circumvent a competitive bidding process required by law or rule by using a sole-source contract for commodities or services.

I recommend that the competitive quoting/bidding process be waived and that the goods/services be purchased as a sole source.

Joseph J. Wall  
Contact Person's Signature

2/5/16  
Date

Mark Deedt  
Supervisor's Signature

2/5/16  
Date

[Signature]  
Director's Signature (required over \$10,000)

2/11/16  
Date

### APPROVAL (Procurement Service Division Use Only)

Verified By:	<u>Randy D. [Signature]</u>	Date	<u>3/8/16</u>
Approved By:	<u>[Signature]</u>	Date	<u>3/9/16</u>

*Procurement Service Division use only*

Requisition # R  
(As Applicable)

Purchase Order # P 215651  
(As Applicable)

Blanket Purchase Order # BPO  
(As Applicable)

**CITY OF HOLLYWOOD, FLORIDA  
DEPARTMENT OF PUBLIC WORKS  
INTER-OFFICE MEMORANDUM**

**DATE:** February 26, 2016  
**TO:** Joel Wasserman, Director Procurement  
**THRU:** Sylvia Glazer, Public Works Director  
**FROM:** Karen Arndt, Assistant Public Works Director *KCA*  
**SUBJECT:** Beach Tech Marina

2016 MAR -1 AM 4:29  
CITY OF HOLLYWOOD  
PROCUREMENT SERVICES  
DIVISION

**ISSUE:**

The Public Works Department is procuring a self-propelled sand sifting/raking machine to remove trash and debris from the beach in areas with limited spaces.

**EXPLANATION:**

Beach sand sifting/raking to remove litter and debris is currently performed utilizing tractors with pull behind sifting/raking equipment. This equipment is too large and does not have an adequate turning radius to operate in tight spaces such as around palm trees and near the seawall. As such the Public Works Department has secured funding to procure a self-propelled machine to gain access to these tight areas.

The Beach Tech Marina equipment is recommended for this procurement and Kässbohrer All Terrain Vehicles Inc is the sole source provider. The Beach Tech Marina has a narrow 5 ½ foot width which allows for use in tight spaces. It also has mechanisms for both raking and sifting which allows for use in dry and wet conditions.

The only other self-propelled machine on the market is the Cherrington 5500. This equipment is much larger than the Beach Tech Marina with an over 8 foot width. This larger width and size is not acceptable as the intent of the equipment is to access tight spaces. The Cherrington machine conveyor system is driven by a sproket mechanism which has proven maintenance and reliability challenges. The Public Works Department previously had a Cherrington self propelled sifter and removed it from inventory through auction due to extensive maintenance and reliability problems.

The Public Works Department has completed on-site demonstrations and obtained price quotes for both the Beach Tech Marina and Cherrington 5500 machines. At \$127,000, the Cherrington machine is over \$17,000 more expensive than the Beach Tech Marina and it's specifications do not meet the needs of the Department.

**RECOMMENDATION:**

Procure the Beach Tech Marina machine from Kässbohrer All Terrain Vehicles Inc as a sole source.



KÄSSBOHRER ALL TERRAIN VEHICLES, INC.

8850 DOUBLE DIAMOND PARKWAY • RENO, NV 89521  
775.857.5000 • FAX 775.857.5010  
www.pistenbullyusa.com • e-mail: Info@pistenbullyusa.com

*PistenBully*

*BeachTech*

January 22, 2016

City of Hollywood  
1600 South Park Drive  
Hollywood, FL 33022  
**Attn: Steve Salafrio**

**RE: BeachTech Marina Proposal**

Steve,

Thanks for the opportunity to provide a quote for a new 2016 BeachTech Marina. The BT Marina beach cleaning machine is the only self propelled beach cleaner that enables the user to both rake and sift the sand. This patented technology insures the sand is thoroughly sanitized, free from cigarette butts, broken glass, bottle caps, etc., and safe for the public use. Additionally, with our cabin and full size windows on all sides of the machine, the operator has the most visibility of any self propelled beach cleaning machine available in the market. A few features of the BeachTech Marina are:

- Can articulate in the center for tight turns
- Has rear wheel steering functions, so you can get extremely close to the edge of the rocks and other beach impediments, life guard towers, piers, etc.
- Can run attachments in front to brush sand from roads, paths, parking etc.
- Has very low low machine noise, and no vibration, that is detrimental to the operator.

The BeachTech Beach Cleaning Machines were chosen as the “Best Practice” by BP during the Gulf oil spill cleanup and BP purchased 30 BeachTech’s to remove oil from the sand. No other beach cleaning company can honestly say this!

The BeachTech is the only machine that can enable the end user to rake and/or sift the beach and being able to have both cleaning methods available in one machine is a great feature for your team.

Additionally, I wanted to note a few things that are important when making a purchase:

- 1) As mentioned above, the BeachTech Marina is a four wheeled machine, complete with 4 extra wide, high flotation, low ground pressure tires. (You do not need a tractor.)
- 2) BeachTech is the largest manufacturer of beach cleaning equipment in the world and our North American Factory Office is located in Reno, NV. All parts and service technicians are located here and we can ship Fed-Ex, DHL or other express couriers.
- 3) All the BeachTech units are manufactured in an ISO Certified facility
- 4) The BeachTech Marina is the only self propelled machine that now comes standard with the Tier 4 engine. We keep up to date with the most current environmental regulations that govern equipment.





KÄSSBOHRER ALL TERRAIN VEHICLES, INC.

8850 DOUBLE DIAMOND PARKWAY • RENO, NV 89521  
775.857.5000 • FAX 775.857.5010  
www.pistenbullyusa.com • e-mail: Info@pistenbullyusa.com

*PistenBully*

*BeachTech*

Here is the proposal for a 2016 BeachTech Marina and the quote is valid through April 28, 2016.

- Patented raking/screening system for dry/wet sand**
- Polyethylene finishing comb with hydraulic lifting mechanism**
- Galvanized components w/two part acrylic paint finish**
- Stainless steel hydraulic pipes & nickel chrome hydraulic cylinder rods**
- Reverse valve to change screening belt direction**
- Tension roller for screen mesh**
- 1-nickel, dime or quarter size high-tension steel cleaning belt**
- High flotation 520mm/20.5" tires**
- Working beach cleaning width of 55", maximum depth of 6"**
- .7 cubic yard collector bin w/discharge height of 5' 4"**
- 3 pt hitch with hydraulic couplings for front end attachments**
- Full one year warranty**
- Maintenance free bearings on all rollers, guaranteed for five years**
- 2 extra set of tines**
- Air conditioning system, factory installed**
- All training for operators and mechanics is included**
- Price does not include any applicable tax**

**FOB: Hollywood, FL: \$109,768**

There are also a few options you may want to consider in the future for your beach cleaning machine, adding more functionality to your operation; I listed them below:

- Front end rake                   \$ 2,160**
- Front end sand blade       \$ 4,995**
- Front end road sweeper     \$ 4,995**

Thank you again for allowing me to present this proposal to you. Let me know what I can do for you

Best,

Evan Huckaby  
BeachTech

1/22/2016

Date

January 25, 2016

City of Hollywood, FL  
2201 N. Ocean Drive  
Hollywood, FL 33020

**Attn: Mr. Steve Salafrio**

Steve,

Thanks for the opportunity to provide a detailed explanation as to why the BeachTech Marina qualifies for a sole source purchase.

As you know from your years working on the beaches of Hollywood, beach cleaning machines are very specialized machines, and their uniqueness is defined by the nature of the work these machines perform.

Beach cleaning machines are not thought of in the same way one might think about police cars, work trucks, or other basic vehicles in a city fleet, where there are a multitude of vendors that can bid on these units and typically the low bid wins. There are only a few beach cleaning machine companies in the entire world, and only two in the USA with self-propelled units.

In order to clean/groom a beach, you can select to rake, sift or perform a combination of both functions. Each one has their merits and here is a quick synopsis:

- Raking—this method helps when the sand is wet, as well as allowing for the machine to run 1-2 mph faster. However, since a raking machine does not pick up the entire sand surface, some debris (that falls between the tines) remains on the beach.
- Sifting—this method picks up the entire sand surface, places the sand onto a rotating screen so that the debris is sifted and removed, returning clean sand to the beach. Since a sifting machine is picking up the entire sand surface, you will drive 1-2 mph slower to ensure all sand is processed.
- Combination—this is best of all options as within one (1) machine, the operator has the ability to rake, sift and/or perform both cleaning functions at the same time. This is big advantage for your operator as by using this cleaning technique, they can be prepared for any issue they may find on the beach, especially dry or wet sand.

**BeachTech is the only company that builds a beach cleaning machine which enables your operator to use both the raking and sifting options, at the same time, in the same machine.**

In addition to BeachTech being able to both rake and sift with one machine, the BeachTech Marina is also the only beach cleaning machine that:

- Articulates in the middle for close access to walls, trees, life guard stands, etc.
- Has four (4) wheel independent drive for maximum traction on all sand surfaces
- Has rear wheel drive to enable sharp turns
- Has the ability to reverse the screen in the event of any jam
- Can customize the screen size to fit your particular application
- Has the ability to run attachments, i.e. brooms, blades, etc. in the front of machine

BeachTech is a factory direct manufacture of beach cleaning equipment and as result, does not utilize dealers in their sales efforts. We have found that not only is it more efficient to have the end user work directly with the manufacture, we have also found that since there is no middle man, there is no additional margin for a dealer, and the end user receives a lower price.

A sole source justification is relevant in this particular case as BeachTech is the only company, in the world, that builds a self-propelled, raking and sifting beach cleaning machine that allows the end user to perform all beach cleaning functions from one machine.

Please let me know if there are additional items you need. Whether it be references, literature, etc., whatever you need, we are here to help, just let me know.

Thanks again, we appreciate your time and look forward to helping you and the City of Hollywood ensure the beaches are clean for the locals and tourists alike!

Best,



KÄSSBOHRER ALL TERRAIN VEHICLES, INC.

*BeachTech*

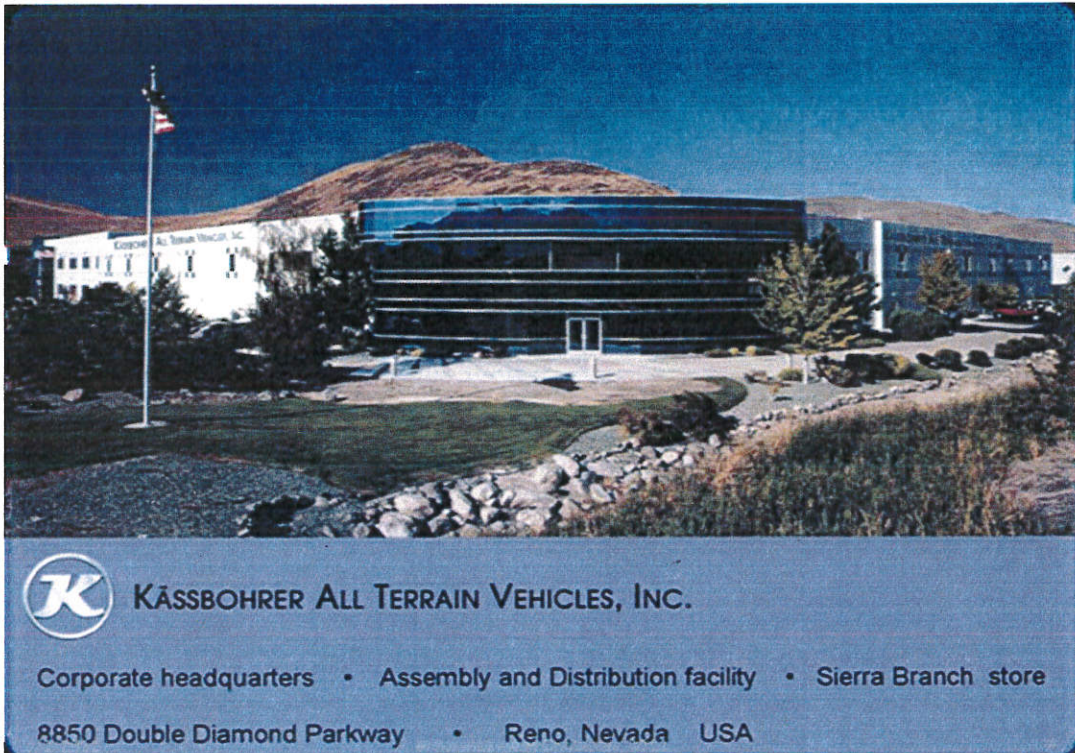

KÄSSBOHRER ALL TERRAIN VEHICLES, INC.

Corporate headquarters • Assembly and Distribution facility • Sierra Branch store  
8850 Double Diamond Parkway • Reno, Nevada USA

<http://www.beach-tech.com>

Quotation prepared exclusively for:

Steve Salafrio

HOLLYWOOD, Florida



# BEACHTECH MARINA

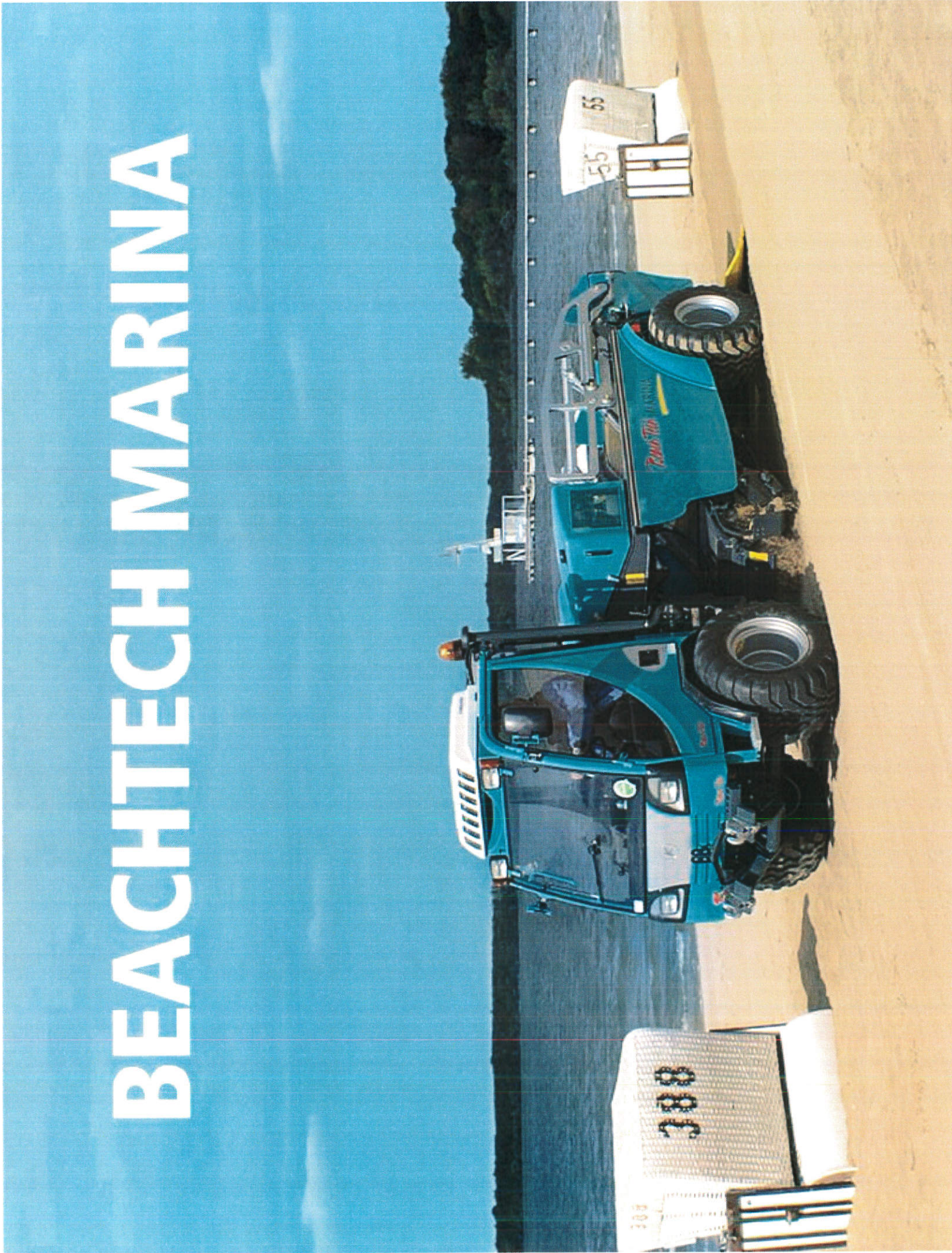

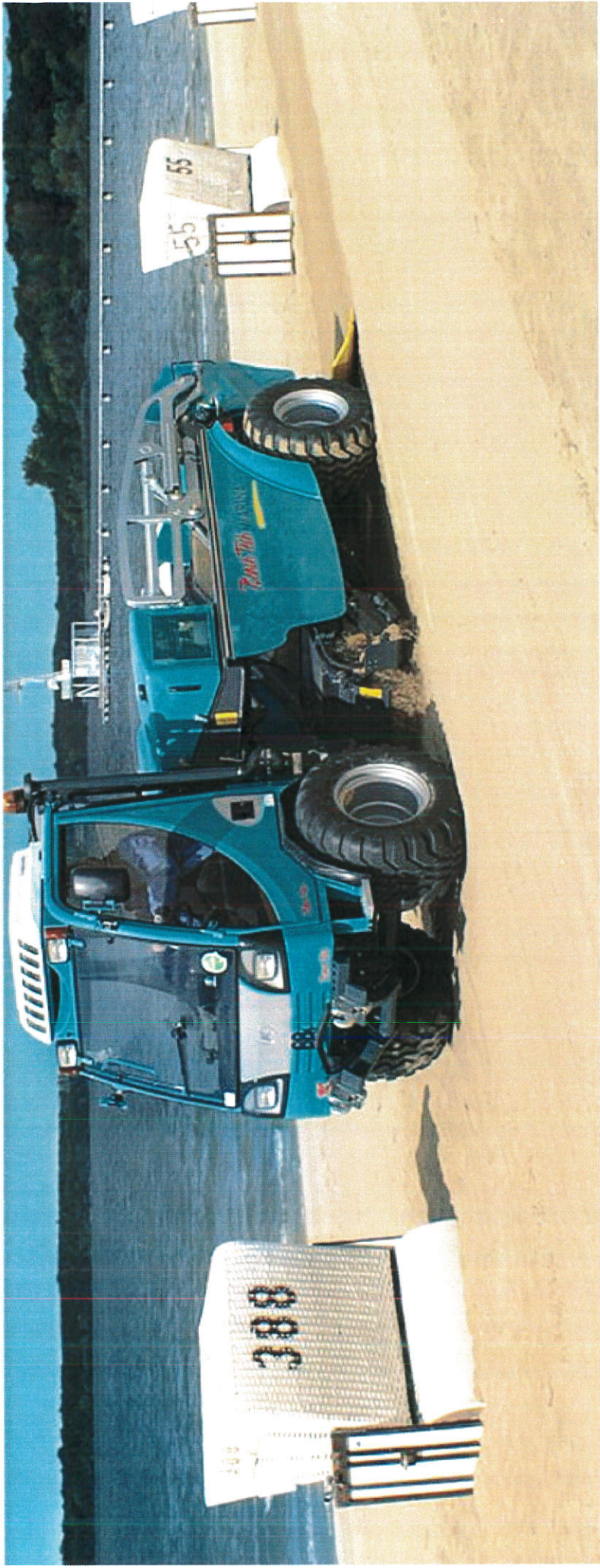

# THE MULTITALENT

## **Tractor and trailer in one**

The self-propelled BeachTech Marina sets standards when it comes to agility, manoeuvrability and quietness. Thanks to articulated front-wheel drive and connectible active rear-wheel drive, it has a sensationally small turning circle. With

a powerful turbo diesel engine, hydrostatic all-wheel drive and low-pressure tyres, nothing gets in the way of the BeachTech Marina. As the BeachTech Marina can be registered for road travel, you can use it anywhere you like. So much flexibility means the highest cost-effectiveness.



# TECHNOLOGY

## Dimensions

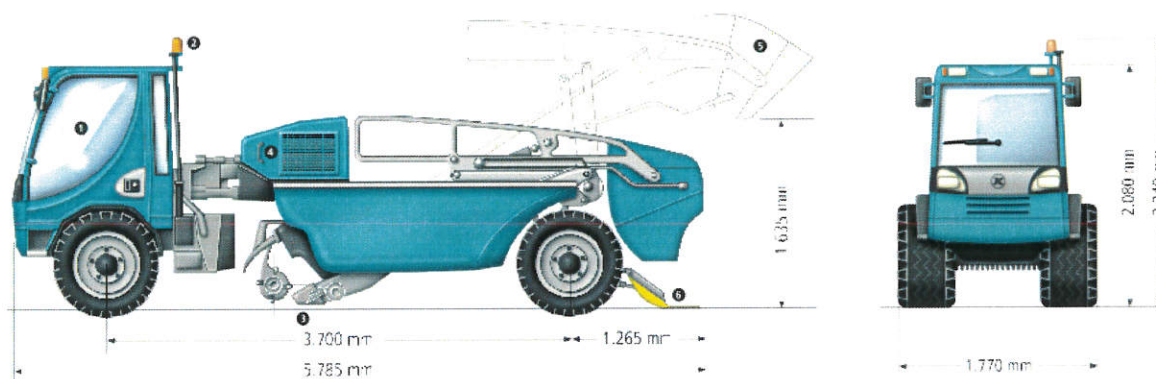

### DIMENSIONS

Overall length	5,785 mm
Width	1,770 mm
Height	2,340 mm
Working width	1,400 mm
Loading volume	0.5 m <sup>3</sup>
Discharging height	1,635 mm

### WEIGHT

Net weight	2,500 kg / 5,500 lbs
Payload	1,000 kg / 2,200 lbs
Gross weight limit	3,500 kg / 7,700 lbs

### PERFORMANCE DATA

max. cleaning performance	15,000 m <sup>2</sup> /h / 3.5 acres/h
Road legal	yes
Top speed	32 km/h

### ENGINE

This web page uses cookies [more information](#)  
 Number of cylinders 4

OK

Torque	120 Nm/ 2,000 rpm			
Model	TECHNOLOGY	SERVICE	1,499	
		SPARE PARTS	BEACHTECH WORLD	
			EN	
Type	Kubota, turbo diesel			
Power	33.0 kW (45 hp)			

**ATTACHMENTS**

Front hitch with 3-point mounting (Cat. II required): mowing unit, scraper, blade, road sweeper

# SMALL TURNING CIRCLE

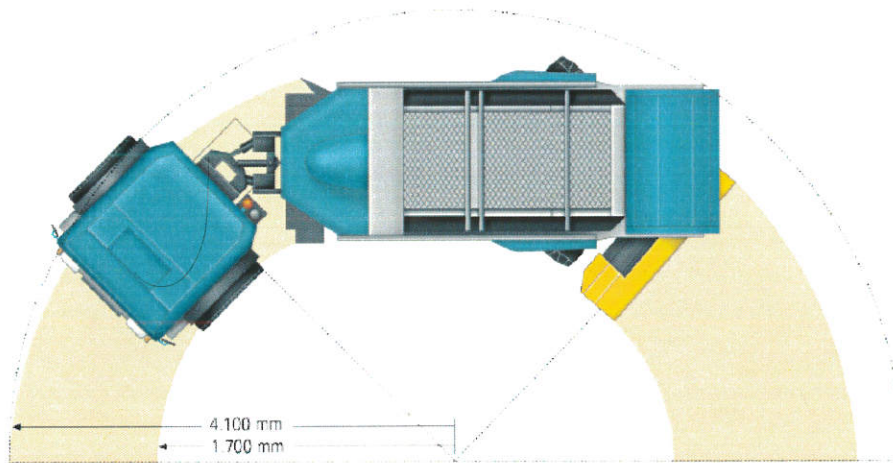

**Small turning circle - big impact**

The special feature of the BeachTech Marina is that it can handle every curve and every corner. Our innovative vehicle concept: Articulated front-wheel drive and connectible active rear-wheel drive. This reduces the turning circle during cleaning to an inner radius of just 1.85 m. Thus, the Marina can even clean in tight spaces around sun loungers.

**Road approval**

Beach hopping is no problem for the BeachTech Marina. Thanks to road approval

potential, it can travel from one beach to another - flexible use for the greatest cost-effectiveness.

**Customised cockpit**

The ergonomically designed cockpit and the joystick make it easy to control. Large electrically operated mirrors ensure excellent all-round visibility. The comfortable two-seater driver's cab is available with folding roof or air conditioning.



MODELS TECHNOLOGY SERVICE SPARE PARTS BEACHTECH WORK

EN



# AT A GLANCE



### 1-MAN OPERATION EASY TO HANDLE

All vehicle functions are controlled directly from the cab.

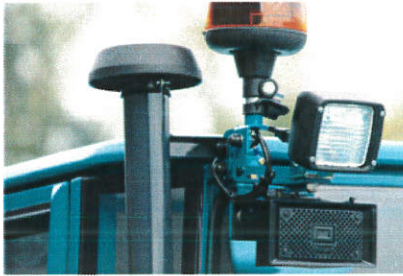

### SAFETY FEATURES EXTENSIVE EQUIPMENT

Equipped with many safety features (acoustic warning alarms in the event of incorrect operations, reversing alarm, electrically operated exterior mirrors for optimum visibility, warning beacons and seatbelts).



### WORKING WIDTH COVERAGE

Working width of 1.40 m for coverage of up to 15,000 m<sup>2</sup>/h.

## DOWNLOAD

You'll find more information about the vehicle here.



### BROCHURE

BeachTech Marina

file type: PDF  
file size: 5.1 MB

[Download](#)

This web page uses cookies [more information](#)

OK

USER NAME  PASSWORD  **LOG IN**

[Forgot Username?](#) [Forgot Password?](#)

[Create an Account](#)

# Search Results

**Current Search Terms: kassbohrer\***

Your search for "KASSBOHRER\*" returned the following results...

**Notice:** This printed document represents only the first page of your SAM search results. More results may be available. To print your complete search results, you can download the PDF and print it.

Entity	<b>KASSBOHRER ALL TERRAIN VEHICLES, INC.</b>	Status: <b>Active</b>
<b>DUNS: 874997943</b>	<b>CAGE Code: 6W799</b>	<input type="button" value="View Details"/>
<b>Has Active Exclusion?: No</b>	<b>DoDAAC:</b>	
<b>Expiration Date: 09/20/2016</b>	<b>Delinquent Federal Debt? No</b>	
<b>Purpose of Registration: All Awards</b>		

### Glossary

#### Search

#### Results

Entity

Exclusion

#### Search

#### Filters

By Record Status

By Functional Area - Entity Management

By Functional Area - Performance Information

SAM | System for Award Management 1.0

IBM v1.P.46.20160226-1435

WWW6

**Note to all Users:** This is a Federal Government computer system. Use of this system constitutes consent to monitoring at all times.



USER NAME  PASSWORD  **LOG IN**

[Forgot Username?](#) [Forgot Password?](#)

[Create an Account](#)

# Entity Dashboard

- [Entity Summary](#)
- [Entity Record](#)
- [Core Data](#)
- [Assertions](#)
- [Reps & Certs](#)
- [POCs](#)
- [Reports](#)
- [Service Contract Report](#)
- [BioPreferred Report](#)
- [Exclusions](#)
- [Active Exclusions](#)
- [Inactive Exclusions](#)
- [Excluded Family Members](#)

[RETURN TO SEARCH](#)

KASSBOHRER ALL TERRAIN VEHICLES, INC. 750A SOUTH ROCK BLVD  
 DUNS: 874997943 CAGE Code: 6W799 RENO, NV, 89502-4140 ,  
 Status: Active UNITED STATES

Expiration Date: 09/20/2016  
 Purpose of Registration: All Awards

## Entity Overview

**Entity Information**

**Name:** KASSBOHRER ALL TERRAIN VEHICLES, INC.  
**Business Type:** Business or Organization  
**POC Name:** Scott Merrill  
**Registration Status:** Active  
**Activation Date:** 09/21/2015  
**Expiration Date:** 09/20/2016

**Exclusions**

Active Exclusion Records? No

SAM | System for Award Management 1.0

IBM v1.P.46.20160226-1435

WWW6



**Note to all Users:** This is a Federal Government computer system. Use of this system constitutes consent to monitoring at all times.