



CITY OF HOLLYWOOD, FLORIDA

PROCUREMENT SERVICES DIVISION

CITY OF HOLLYWOOD
PROCUREMENT SERVICES
DIVISION
2016 MAR -5 AM 12:10

Piggybacking Request Form
(Use for purchase(s) over \$15,000, when piggybacking off other contracts)

Date: February 29, 2016

Department/Office: Public Works

Division/Area: Fleet Maintenance

Contact Person: Joel Wall / Sylvia Glazer

Title: Fleet Coordinator / Public Works Director

Phone: 954.967.4555 / 954.967.4526

Email: jwall@hollywoodfl.org / sqlazer@hollywoodfl.org

1. Requested Vendor: Rechtien International Truck, Inc. Vendor Number: 5761

Address: 3787 Interstate Park Rd., Riviera Beach, FL 33404

Contact Person: John Bradley

Title: Governmental Sales Manager

Phone: 561-882-9050

Email: bradley@rechtien.com

2. Contract title requesting to piggyback?

Awarding Agency: Florida Sheriffs Association Contract Bid Award (15-13-0904).

Contract Expiration Date: September 30, 2016

Copy of Contract and Awarding Agency documentation is attached.

Yes No

AT40G

3. Product/Service being requested (be specific). (1) 2016 International Terrastar SFA (4x2) w/Altec AT40G Telescoping/Articulating Aerial Device, Specification #9.

4. Detailed description of the products/services function and purpose. The Urban Forestry Division seeks authorization to purchase the 2016 International Terrastar SFA (4x2) w/Altec AT40G Telescoping/Articulating Aerial Device (Bucket Truck) to replace the existing 1999 Altec TA40 Aerial Truck that has reached its useful life expectancy. This truck will perform removal of brush from City rights-of-way, debris from vehicular accidents and natural disasters as well as brush from City crew tree trimming. 2016 International Terrastar SFA (4x2) w/Altec

Procurement Service Division use only

Requisition # R _____
BPO _____
(As Applicable)

Purchase Order # P _____
(As Applicable)

Blanket Purchase Order # _____
(As Applicable)

AT40G Telescoping/Articulating Aerial Device was tested to best perform for the needed requirements in the daily operations of the Public Works Urban Forestry Division.

5. Please explain what process the Department/Office took to verify and/or identify this contract. Recommended by the Public Works Department.

6. Were alternative contracts evaluated to determine that the City is obtaining the most advantageous contract pricing for the required product/service?

Yes No

Please explain This is the best price going for this vehicle and pricing is based on the Florida Sheriff's Association Contract. The State of Florida Contract did not bid on this model vehicle for this year's contract.

7. Total cost of the requested product/service. \$128,080.00

8. Total estimated annual (fiscal year) cost of requested product/service. (1) vehicle = \$128,080.00
Account Number # 57.5100.14106.590.056452

9. Is this product/service covered by a warranty? Yes No

If yes, please attach a copy of the warranty details.

10. Would this purchase(s) result in the potential of future purchases for related products/services being restricted to a particular vendor or create a specific vendor as sole source provider for related items?

Yes No

If yes, please describe the related products/services and estimated cost(s.) _____

11. Would this purchase(s) result in any future maintenance costs which are not included in the initial purchase?

Yes No

If yes, please attach a draft maintenance plan which includes cost estimates and funding source(s.)

12. Is this a grant related purchase? Yes No

If yes, please provide details (timeline, expiration dates, milestones, special procurement requirements, etc.)

Will this require matching funds? Yes No

What is the grant source? N/A

What is the grant (dollar) amount? N/A

13. Please complete an advanced search of the vendor recommended for award on the Federal Government's Excluded Parties List System at www.epls.gov.

Date of Advanced Search _____

Procurement Service Division use only

Requisition # R _____
BPO _____
(As Applicable)

Purchase Order # P _____
(As Applicable)

Blanket Purchase Order # _____
(As Applicable)

Company Name(s) Searched

Search Results

REQUESTING DEPARTMENT RECOMMENDATION

Note: By signing and returning this form, you are verifying and acknowledging that you have reviewed all portions (scope, terms, conditions, pricing, etc.) of the requested contract and recommend its approval based on the contract complying with the City of Hollywood's scope and pricing requirements and to the best of your knowledge the contract does not violate any applicable policy, statute, governing rule or regulation.

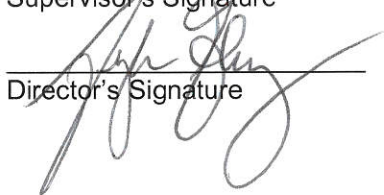

Contact Person's Signature

Supervisor's Signature



Director's Signature

2/29/16

Date
2/29/16

Date
3/1/16

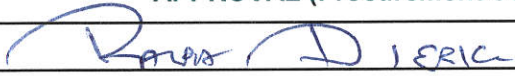
Date

APPROVAL (Procurement Service Division Use Only)			
Verified By:		Date	<u>3/10/16</u>
Approved By:		Date	<u>3/10/16</u>

Procurement Service Division use only

Requisition # R _____
BPO _____
(As Applicable)

Purchase Order # P _____
(As Applicable)

Blanket Purchase Order # _____
(As Applicable)

2/29/2016



Rechtien International Trucks, Inc

FLORIDA SHERIFF'S ASSOCIATION Contract 15-13-0904

Customer: City of Hollywood

Specification: 9 **Region:** Southern

Base Price:

Contract Options:

		Quantity	Unit Cost	extended
		1	\$ 48,505.00	\$48,505.00
08HAH	Dealer installed electric brake controller & factory wiring	1	\$ 494.00	\$ 494.00
16JNZ	Air ride (self contained) driver seat and two man passenger seat	1	\$ 756.00	\$ 756.00
195GVWR	19,500 lbs. GVWR	1	\$ 133.00	\$ 133.00
13ARC	Allison 1000 RDS transmission (includes PTO gear)	1	\$ 237.00	\$ 237.00
13WDH	Wiring interface harness with automatic transmission	1	\$ 23.00	\$ 23.00
08XAH	Manual reset circuit breakers in lieu of fuses	1	\$ 93.00	\$ 93.00
08WRP	Headlights on with wipers - automatically	1	\$ 21.00	\$ 21.00
08WPP	Automatic engine shutdown for low oil pres or high coolant temp	1	\$ 138.00	\$ 138.00
1570	Front tow hooks	1	\$ 69.00	\$ 69.00
O8178	Auxiliary power source - plug in receptacle	1	\$ 28.00	\$ 28.00
08WXB	Headlights on warning buzzer -	1	\$ 46.00	\$ 46.00
40LMT	Extended vehical coverage 60-mos or 150,000 mi. - excluding engine & transmission	1	\$ 827.00	\$ 827.00
40KX	Extended engine coverage 60-mos, 150,00 mi., or 5,400 hrs. includes after-treatment system	1	\$ 1,974.00	\$ 1,974.00

Non-Contract Options:

AT40G	Altec model AT40G telescoping aerial device per quote 311264	1	\$ 72,339.00	\$ 72,339.00
5YREXT	5-Year extended warranty for labor, material, and expenses (No Travel) for an Altec AT37G or AT40G aerial device	1	\$ 2,397.00	\$ 2,397.00
			\$ -	\$ -
			\$ -	\$ -
			\$ -	\$ -
			\$ -	\$ -
			\$ -	\$ -

Estimated delivery of completed unit is 270 to 300 days ARO

Total:			\$ 128,080.00	\$ 128,080.00
	**Florida Waste Tire Fee		\$ -	\$ -
	**Florida Waste Battery Fee		\$ -	\$ -
Total Purchase Order Amount:			\$ 128,080.00	\$ 128,080.00

Cab Color:	White
Body Color:	N/A

**included in base price

Prepared By:

John Bradley
 Rechtien International Trucks, Inc.
 3787 Interstate Park Road
 Riviera Beach, FL 33404
 office - 561.882.9050
 fax - 561.882.0218
 cell - 561.818.4374
 email - bradley@rechtien.com

BID AWARD ANNOUNCEMENT

15-13-0904

Effective Dates:

October 1, 2015– September 30, 2016

**Cab & Chassis Trucks
& Other Fleet Equipment**

***Participating Sheriffs Offices & Local Governmental
Agencies of the State of Florida***

Coordinated By

**The
Florida Sheriffs Association
& Florida Association of Counties**





**FLORIDA SHERIFFS ASSOCIATION
& FLORIDA ASSOCIATION OF COUNTIES**

**17,501 LB. GVWR CAB & CHASSIS (DUAL REAR WHEEL) - 4X2
SPECIFICATION #9**

2016 International Terrastar

The International Terrastar purchased through this contract comes with all the standard equipment as specified by the manufacturer for this model and FSA's base vehicle specification(s) requirements which are included and made a part of this contract's vehicle base price as awarded by specification by zone.

ZONE:	Western	Northern	Central	Southern
BASE PRICE:	\$49,166.00	\$48,166.00	\$45,145.00	\$48,505.00

While the Florida Sheriffs Association and Florida Association of Counties have attempted to identify and include those equipment items most often requested by participating agencies for full size vehicles, we realize equipment needs and preferences are going to vary from agency to agency. In an effort to incorporate flexibility into our program, we have created specific add/delete options which allow the purchaser to tailor the vehicle to their particular wants or needs.

The following equipment delete and add options and their related cost are provided here to assist you in approximating the total cost of the type vehicle(s) you wish to order through this program. Simply deduct the cost of any of the following equipment items you wish deleted from the base unit cost and/or add the cost of any equipment items you wish added to the base unit cost to determine the approximate cost of the type vehicle(s) you wish to order.

NOTE: An official listing of all add/delete options and their prices should be obtained from the appropriate dealer in your zone when preparing your order. Additional add/delete options other than those listed here may be available through the dealers, however, those listed here must be honored by the dealers in your zone at the stated prices.

VEHICLE:	Terrastar			
DEALER:	Maudlin International Trucks, LLC	Maudlin International Trucks, LLC	Sun State International Trucks	Rechtien International Trucks, Inc
ZONE:	Western	Northern	Central	Southern
BASE PRICE:	\$49,166.00	\$48,166.00	\$45,145.00	\$48,505.00

Order Code	Delete Options	Western	Central	Southern
		& Northern		
D16WCT ¹ 16WCT ² 16WCS ³	Gas engine in lieu of diesel engine	NA	NA	NA
	Air conditioning	\$425.00 ¹	\$790.00 ²	\$704.00 ³
D8RBK ¹ D8RKB ² D8RBK ³	AM/FM stereo radio	\$173.00 ¹	\$295.00 ²	\$259.00 ³
	Passenger air bag	NA	NA	NA
	On-Star	NA	NA	NA
	Satellite radio	NA	NA	NA
15SSW ¹ 15SSX ² 15SSW ³	AFT tank for 18 gallon mid ship	\$325.00 ¹	\$635.00 ²	\$650.00 ³
	40 gallon aft mounted fuel tank in lieu of the under ca mounted tank ²			
	Top Draw; Rectangular, Steel; 15" Tank Depth, 40 U.S. Gal., Mounted Between Frame Sidemembers and Behind Rear Axle. May restrict some body mounting configurations. Contact dealer for availability ³			

Order Code	Add Options	Western	Central	Southern
		& Northern		
13ASW ²	Engine/transmission upgrade - specify <i>ALLISON 1350 RDS TRANSMISSION²</i>	NA	\$635.00 ²	NA
	Engine/transmission upgrade - specify	NA	NA	NA
13ASV ²	Engine/transmission upgrade - specify <i>ALLISON 1350 RDS TRANSMISSION IN LIEU OF 1000 HS²</i>	NA	\$438.00 ²	NA
	Bi-fuel model - specify	NA	NA	NA
	CNG prep - specify	NA	NA	NA
	CNG conversion (discuss with dealer)	NA	NA	NA
	LPG conversion (discuss with dealer)	NA	NA	NA
15DYD ¹ 15DYD ² 15DYD ³	Dual fuel tanks	\$1,738.00 ¹	\$1,810.00 ²	\$1,118.00 ³
8GXC ¹ 8GHU ² 8GXC ³	Alternator, extra HD - specify amps <i>200 AMP²</i>	\$429.00 ¹	\$390.00 ²	\$447.00 ³
	<i>210 Amp alternation in lieu of 160 Amp³</i>			
	Dual alternators	NA	NA	NA
	Idle control	Std	Std	Std
8HAH ¹ 8HAH ² 08HAH ³	Electric brake controller <i>DEALER INSTALLED²</i>	\$645.00 ¹	\$544.00 ²	\$494.00 ³
	<i>Dealer installed brake controller and rear trailer plug. Factory wiring from under dash to rear of frame³</i>			

VEHICLE:	Terrastar			
DEALER:	Maudlin International Trucks, LLC	Maudlin International Trucks, LLC	Sun State International Trucks	Rechtien International Trucks, Inc
ZONE:	Western	Northern	Central	Southern
BASE PRICE:	\$49,166.00	\$48,166.00	\$45,145.00	\$48,505.00

14888 ¹ 14888 ² 14888 ³	Limited slip differential on rear axles	\$1,012.00 ¹	\$1,105.00 ²	\$1,057.00 ³
16WRZ ¹ 16WRZ ² 16WRZ ³	Manufacturer's model upgrade package (specify pkg. bid) <i>Premium Interior For extended cab add \$100.00 For crew cab add \$600.00</i> ¹ <i>premium interior package w/ standard cab - includes 16WJU for order code 16CAB extended cab use order code 16wsj add \$747.00 for order code 16196 crew cab use order code 16wsj add \$1,246</i> ² <i>Premium Interior Package with standard cab. *****For Extended cab - order code 16CAB use order code 16WST - Price \$357.00 *****For Crew cab (4-door) - order code 16196 use order code 16WSJ - Price \$563.00</i> ³	\$650.00 ¹	\$300.00 ²	\$286.00 ³
16WJU ¹ 16WJU ² 16WJU ³	Power windows/door locks <i>for 2 - door cab only . for 4 - door cab (19196) wuse order code 16wjy add \$601</i> ² <i>for use with standard and extended cab - order code 16CAB - only. *****For crew cab (4-door) - order code 16196 use order code 16WJV - Price \$608.00</i> ³	\$350.00 ¹	\$350.00 ²	\$345.00 ³
5708 ¹ 5708 ² 05708 ³	Speed control/tilt steering wheel <i>tilting steering column speed control standard</i> ² <i>Tilt steering column with standard speed control</i> ³	\$120.00 ¹	\$120.00 ²	\$117.00 ³
8RME ¹ 8RME ² 08RME ³	AM/FM radio with single CD <i>AM/FM/WB/Clock/3MM Auxiliary Input, with Multiple Speakers, With CD Player</i> ³	\$425.00 ¹	\$460.00 ²	\$446.00 ³
	Sliding rear window	NA	NA	NA
16JNZ ¹ 16JNT ² 16JNZ ³	40/20/40 seat in vinyl <i>air ride driver seat and 2 man passenger seat-vinyl</i> ² <i>Air ride (self contained) driver seat and two man passenger seat. Includes factory option code 16KAW</i> ³	\$750.00 ¹	\$478.00 ²	\$756.00 ³
16JPA ¹ 16JNV ² 16JPA ³	40/20/40 seat in cloth <i>air ride driver seat and 2 man passenger seat-cloth</i> ² <i>Air ride (self contained) driver seat and two man passenger seat. Includes factory option code 16SMK</i> ³	\$900.00 ¹	\$559.00 ²	\$871.00 ³
	Side air bags	NA	NA	NA
3K ¹ 3K ² 3K ³	Third key	\$15.00 ¹	\$20.00 ²	\$18.00 ³
16CAB ¹ 16CAB ² 16CAB ³	Extended cab <i>2 DOOR cab with individual driver and passenger front seats, bench seta in rear, cab to axle CA availabe 60" , 84"</i> ² <i>2-door extended cab with fixed front driver and passenger seats and rear bench seat. Includes factory option codes 16SMV, 16KAV, 16SMN, and 16WSX</i> ³	\$3,208.00 ¹	\$3,071.00 ²	\$4,441.00 ³
16196 ¹ 16196 ² 16196 ³	Crew cab model <i>4- door cab with bench seats front and rear, cab to axle ca available 60" , 84"</i> ² <i>4-door cab with bench seats front and rear. Includes factory option codes 16SMT, and 16WSG</i> ³	\$7,430.00 ¹	\$7,182.00 ²	\$8,138.00 ³
	Cutaway cab	NA	NA	NA
516005 ³	Cab steps	Std	Std	Std ³
	Left-hand pillar mounted 6" spotlight with clear halogen bulb, dealer installed	NA	NA	NA

VEHICLE:	Terrastar			
DEALER:	Maudlin International Trucks, LLC	Maudlin International Trucks, LLC	Sun State International Trucks	Rechtien International Trucks, Inc
ZONE:	Western	Northern	Central	Southern
BASE PRICE:	\$49,166.00	\$48,166.00	\$45,145.00	\$48,505.00

	Left & right-hand pillar mounted 6" spotlight with clear halogen bulb, dealer installed	NA	NA	NA
	Vent visors - stick-on style	NA	NA	NA
	Rainshields - flange style	NA	NA	NA
09WAC ³	Bug shield <i>Bug Screen, mounted behind grille³</i>	NA	NA	\$123.00 ³
WGG ¹ WGG ² WGG ³	Wrap-around grille guard	NA ¹	NA ²	NA ³
	Spray-in liner (Rhino, Line-X or approved equivalent)	NA	NA	NA
777944102 ¹ 7709449040 ² 7779448102 ³	All terrain tread tires on rear <i>Goodyear 622RSD³</i>	\$42.00 ¹	\$33.00 ²	\$41.00 ³
26DRR ¹ 29007 ² 29007 ³	Full size spare tire & rim <i>Includes factory option code 26DRR³</i>	\$500.00 ¹	\$605.00 ²	\$612.00 ³
	Nitrogen filled tires including spare tire	NA	NA	NA
	Daytime running lights	Std	Std	Std
	Immobilize daytime running lights	NA	NA	NA
19GVW ¹ 195GVWR ² 195GVWR ³	19,000 lb. GVWR <i>19,500 lbs. GVWR³</i>	\$138.00 ¹	\$139.00 ²	\$133.00 ³
	22,000 lb. GVWR	NA	NA	NA
13ARC ¹ 13ARC ² 13ARC ³	PTO provision, automatic <i>Allison RDS transmission in lieu of HS includes 13 WDH & 8HAB²</i> <i>Allison 1000 RDS transmission³</i>	\$276.00 ¹	\$270.00 ²	\$273.00 ³
	PTO transmission driven, manual (dealer installed)	NA	NA	NA
DLRPTO ¹ DLRPTO ² DLRPTO ³	PTO transmission driven, automatic (dealer installed) <i>for use with allison RDS transmission contact dealer for availability²</i> <i>For use with Allison RDS transmission order code 13ARC. Contact dealer for availability.³</i>	\$2,600.00 ¹	\$2,306.00 ²	\$2,381.00 ³
EC4000 ¹ EC4000 ² EC4000 ³	4,000 lb. EH Auto Crane, or approved equivalent, with crane reinforcements with manual outriggers <i>Stellaer or equal electric over hydraulic²</i> <i>Stellar 4000 lbs. capacity³</i>	\$18,500.00 ¹	\$15,350.00 ²	\$14,618.00 ³
6132D547 ¹ 8132D54J ² 6132DL ³	Appropriate Auto Crane body with shelf package, 12" bumper with crank outriggers, or approved equivalent <i>Knapheide 9' crane body²</i> <i>11' Knapheide crane body³</i>	\$21,000.00 ¹	\$14,615.00 ²	\$15,281.00 ³
EC5000 ¹ EC5000 ² EC5000 ³	5,000 lb. EH Auto Crane, or approved equivalent, with crane reinforcements with manual outriggers <i>stellar or equal - electric over hydraulic²</i> <i>Stellar 5000 lbs. capacity³</i>	\$25,000.00 ¹	\$17,450.00 ²	\$16,267.00 ³

VEHICLE:	Terrastar			
DEALER:	Maudlin International Trucks, LLC	Maudlin International Trucks, LLC	Sun State International Trucks	Rechtien International Trucks, Inc
ZONE:	Western	Northern	Central	Southern
BASE PRICE:	\$49,166.00	\$48,166.00	\$45,145.00	\$48,505.00

LG15 ¹ 15LG ² 15LG ³	1,500 lb. lift gate <i>requires body</i> ²	\$3,400.00 ¹	\$3,575.00 ²	\$3,202.00 ³
03WAP ³	12,000 lb. winch with remote Front stabilizer bars <i>Contact dealer for availability</i> ³	NA	NA	NA
8TMG ¹ 8TMG ² 08TMG ³	Trailer towing package, to include heavy duty flashers, wiring for trailer plug (7 prong round), and class IV frame mounted trailer hitch with 2" square removable receiver, 1" shank with 2" ball. May be dealer installed. <i>body must be installed prior to installation</i> ² <i>Body must be installed prior to installation. Includes dealer installed hitch and electric brake controller.</i> ³	\$800.00 ¹	\$425.00 ²	\$814.00 ³
GO184-9 ¹ KDBF912A ² KDBF912A ³	2-3 yd. dump with manual ground control tarp (requires 60" CA) <i>9' dump body with 12" sides- includes order codes 13ARC & DLRPTO</i> ² <i>9' 2-3 yard dump with 12" sides. Includes 13ACR & DLRPTO</i> ³	\$9,500.00 ¹	\$11,990.00 ²	\$9,921.00 ³
GO184-11 ¹ KDBF1112A ² KDBF1112A ³	2-3 yd. dump with manual ground control tarp (requires 84" CA) <i>11' dump body with 12" sides- includes order codes 13ARC & DLRPTO</i> ² <i>11' 2-3 yard dump with 12" sides. Includes 13ACR & DLRPTO</i> ³	\$9,900.00 ¹	\$12,656.00 ²	\$10,513.00 ³
PVMXS12 ¹ PVMXS-123C ² PVMXS-123C ³	12 ft. flat stake body with 40" sides all around (requires 84" CA)	\$4,800.00 ¹	\$5,895.00 ²	\$6,157.00 ³
PVMXS16 ¹ PVMXS-163C ² PVMXS-163C ³	16 ft. flat stake body with 40" sides all around (requires 120" CA)	\$5,700.00 ¹	\$7,527.00 ²	\$7,034.00 ³
FD16 ¹ PVMXS-163FD ² PVMXS-163CFD ³	16 ft. flatbed dump with manual ground control tarp, 14" sides (requires 120" CA) <i>Includes order codes 13AVV & DLRPTO</i> ² <i>Includes 13ACR & DLRPTO</i> ³	\$11,150.00 ¹	\$9,918.00 ²	\$13,514.00 ³
BR16 ¹ PVMXS-163CD ² PVMXS-163CDP ³	16 ft. contractors dump with manual ground control tarp, 14" sides (requires 120" CA) <i>includes order codes 13AVV & DLRPTO</i> ² <i>Includes 13ACR & DLRPTO</i> ³	\$14,700.00 ¹	\$17,100.00 ²	\$15,056.00 ³
19roll ¹ 21RB ² 19RB ³	19 ft. rollback wrecker with wheel lift (requires 120" CA) <i>60AAA, 13ARC, DLRPTO, & 13ASV</i> ² <i>Includes order codes 195DVWR, 60AAA, 13ARC, DLRPTO, & 13WDH</i> ³	\$27,000.00 ¹	\$27,221.00 ²	\$27,036.00 ³
CA84 ² CA84 ³	84" cab to axle	NC	NC ²	NC ³
120CA ¹ CA120 ² CA120 ³	120" cab to axle <i>not available with orders codes 1196 or 16cab</i> ² <i>Not available with order codes 16CAB or 16196. Includes factory option code 01WEC.</i> ³	\$360.00 ¹	\$274.00 ²	\$356.00 ³
6132D54 ¹ 1632D54J ² 6132D54J ³	11 ft. utility (requires 84" CA) <i>knapheide or equal includes factor mirrors for use with dual rear wheels</i> ² <i>Knapheide or equal. Wide body for dual rear wheels</i> ³	\$7,500.00 ¹	\$7,860.00 ²	\$8,609.00 ³

VEHICLE:	Terrastar			
DEALER:	Maudlin International Trucks, LLC	Maudlin International Trucks, LLC	Sun State International Trucks	Rechtien International Trucks, Inc
ZONE:	Western	Northern	Central	Southern
BASE PRICE:	\$49,166.00	\$48,166.00	\$45,145.00	\$48,505.00

6108D54J ¹ 6108D54J ² 6108D54J ³	Manufacturer's certified factory standard 9' wide service body for dual rear wheels to include appropriate mirrors - specify. May be dealer installed. (NOTE: If you are ordering a service body, we are advising you to contact your awarded vendor.) <i>knapeide or equal includes factor mirrors for use with dual rear wheels²</i> <i>9' (requires 60" CA)Knapheide or equal. Wide body for dual rear wheels³</i>	\$7,200.00 ¹	\$7,257.00 ²	\$7,010.00 ³
14DV ¹ 14DV ² 14DV ³	Manufacturer's certified factory 14' dry freight wide body with pine floor for dual rear wheels to include appropriate mirrors - specify. (Requires 111" CA). May be dealer installed. (NOTE: If you are ordering a service body, we are advising you to contact your awarded vendor.) <i>supreme or equal 85" insdie height x 96" outside width with roll up rear door²</i> <i>Aluminum 14' x 96" x 84" inside height³</i>	\$8,670.00 ¹	\$6,734.00 ²	\$7,795.00 ³
16DV ¹ 16DV ² 16DV ³	Manufacturer's certified factory 16' dry freight wide body with pine floor for dual rear wheels to include appropriate mirrors - specify. (Requires 129" CA). May be dealer installed. (NOTE: If you are ordering a service body, we are advising you to contact your awarded vendor.) <i>supreme or equal 85" insdie height x 96" outside width with roll up rear door²</i> <i>Aluminum 16' x 96" x 84" inside height³</i>	\$9,040.00 ¹	\$7,750.00 ²	\$8,058.00 ³
20DV ¹ 20DV ²	Manufacturer's certified factory 20' dry freight wide body with pine floor for dual rear wheels to include appropriate mirrors - specify. (Requires 129" CA). May be dealer installed. (NOTE: If you are ordering a service body, we are advising you to contact your awarded vendor.) <i>supreme or equal 85" insdie height x 96" outside width with roll up rear door²</i>	\$10,450.00 ¹	\$9,685.00 ²	NA
18DV ¹ DB8RL ² 12DV ³	Optional body - specify <i>new way diamond back or equal 8-yard rear loader includes order codes CA108, 13ARC & 13WDH²</i> <i>Manufacturer's certified factory 12' dry freight wide body with pine floor for dual rear wheels to include appropriate mirrors - Aluminum 12' x 96" x 84" inside height³</i>	\$9,890.00 ¹	\$40,816.00 ²	\$7,599.00 ³
CANROOF-9 ² 6108D53FJ ³	Optional body - specify <i>CANAPOY Roof medium Height requires order code 6108D54J-9'²</i> <i>Flip Top for use with order code 6108D54J ***** Flip Top option for use with order code 6132D54J - Use order code 6132D54FJ - Price \$1,421.00³</i>	NA	\$3,594.00 ²	\$805.00 ³
CANROOF-11 ² CANROOF-9 ³	Optional body - specify <i>CANAPOY Roof medium Height requires order code 6108D54J-11'²</i> <i>Canopy roof - medium height - requires order code 6108D54J³</i>	NA	\$4,494.00 ²	\$3,289.00 ³
PVMXS-143C ² CANROOF-11 ³	Optional body - specify <i>14ft flat stake body with 40" sides all around (requires 108"CA)²</i> <i>Canopy roof - medium height - requires order code 6132D54J³</i>	NA	\$6,116.00 ²	\$3,918.00 ³
HB8000 ² LEDPKG ³	Optional body - specify <i>13ARC & 13WDH²</i> <i>LED lighting package for Body and cab & chassis. Includes factory codes 08TRS, 08WPH, and 08XGT³</i>	NA	\$45,237.00 ²	\$517.00 ³
	Powder coating for utility body	NA	NA	NA

VEHICLE:	Terrastar			
DEALER:	Maudlin International Trucks, LLC	Maudlin International Trucks, LLC	Sun State International Trucks	Rechtien International Trucks, Inc
ZONE:	Western	Northern	Central	Southern
BASE PRICE:	\$49,166.00	\$48,166.00	\$45,145.00	\$48,505.00

8THB ¹ 8THB ² 08THB ³	Backup alarm - Factory Installed	\$110.00 ¹	\$120.00 ²	\$113.00 ³
DLRBU ¹ DLRBA ² DLRBA ³	Backup alarm - Dealer Installed	\$150.00 ¹	\$125.00 ²	\$120.00 ³
	Backup camera with 3.5" LCD (rear mounted camera to provide wide angle field of vision at rear of vehicle) - Factory Installed	NA	NA	NA
BUC ¹ BUC ² BUC ³	Backup camera with 3.5" LCD (rear mounted camera to provide wide angle field of vision at rear of vehicle) - Dealer Installed	\$1,550.00 ¹	\$1,250.00 ²	\$980.00 ³
108Ca ¹ CA108 ² CA108 ³	Optional equipment - specify <i>108CA</i> ¹ <i>not available with order code 16196</i> ² <i>Not available with order code 16196</i> ³	\$126.00 ¹	\$130.00 ²	NC ³
13WDH ¹ 13WDH ² 13WDH ³	Optional equipment - specify <i>Body builder transmission wiring interface</i> ¹ <i>wiring interface harness, with automatic transmission, for body builder interface</i> ² <i>Wiring interface harness, with automatic transmission, for body builder controls</i> ³	\$1,292.00 ¹	\$22.00 ²	\$23.00 ³
4SBL ¹ 14TAC ² 14TCH ³	Optional equipment - specify <i>Air compressor</i> ¹ <i>air ride rear suspension, includes 4sbc</i> ² <i>Air ride rear suspension. Includes order code 14SBL</i> ³	\$727.00 ¹	\$2,015.00 ²	\$1,921.00 ³
8WPZ ¹ 4SBC ² 04SBL ³	Optional equipment - specify <i>Test exterior lights</i> ¹ <i>13.2 CFM, air compressor and tank for air source on hydraulic brake chassis</i> ² <i>Bendix Tu-Flo 550 13.2 CFM Capacity air compressor; and tank for Air Source on Hydraulic Chassis.</i> ³	\$40.00 ¹	\$770.00 ²	\$743.00 ³
8XAH ¹ 8WPZ ² 08WPZ ³	Optional equipment - specify <i>Circuit breakers</i> ¹ <i>test exterior lights pre trip exterior light inspection, flashes vehicle lights in specific sequence for walk around</i> ² <i>Test Exterior Lights - pre-trip exterior light inspection flashes vehicle lights in a specific sequence for walk around inspection.</i> ³	\$95.00 ¹	\$40.00 ²	\$39.00 ³
60AAA ¹ 8XAH ² 08XAH ³	Optional equipment - specify <i>RPM</i> ¹ <i>manual reset circuit breakers in lieu of fuses</i> ² <i>Manual Reset circuit breakers in lieu of fuses</i> ³	\$655.00 ¹	\$90.00 ²	\$93.00 ³
8WRB ¹ 60AAA ² 60AAA ³	Optional equipment - specify <i>Headlights on with wipers</i> ¹ <i>remote power module for body builder interface</i> ² <i>Remote Power Module for body builder interface - 6-inputs and 6-outputs with switches on dash</i> ³	\$140.00 ¹	\$550.00 ²	\$649.00 ³

VEHICLE:	Terrastar			
DEALER:	Maudlin International Trucks, LLC	Maudlin International Trucks, LLC	Sun State International Trucks	Rechtien International Trucks, Inc
ZONE:	Western	Northern	Central	Southern
BASE PRICE:	\$49,166.00	\$48,166.00	\$45,145.00	\$48,505.00

8WPP ¹ 8WRP ² 08WRP ³	Optional equipment - specify Engine shutdown ¹ headlights on with wipers ² Headlights on with wipers - automatically ³	\$140.00 ¹	\$20.00 ²	\$21.00 ³
8HAB ¹ 8WPP ² 08WPP ³	Optional equipment - specify Body builder wiring ¹ automatic engine shutdown system for low oil pressure or high coolant temperature ² Automatic engine shutdown system for low oil pressure or high coolant temperature ³	\$95.00 ¹	\$140.00 ²	\$138.00 ³
1570 ¹ 8HAB ² 08HAB ³ 01570 ³	Optional equipment - specify Front tow hooks ¹ body builder interface wiring for lighting ² Body builder interface wiring for lighting ³	\$70.00 ¹	\$90.00 ²	\$94.00 ³
08718 ³	Optional equipment - specify Front tow hooks ³ Auxiliary power source - cigar type receptacle without plug & cord. ³	NA	NA	\$69.00 ³
08WXB ³	Optional equipment - specify Headlight Warning Buzzer - Sounds when headlight switch is on and ignition switch in the off position. ³	NA	NA	\$46.00 ³
16SMM ³	Optional equipment - specify Air ride driver seat and non-suspension passenger seat. ³	NA	NA	\$618.00 ³
Temp ¹	Temporary tag	\$15.00 ¹	NA	NA
Trans ¹ TRANSTAG ² TRANSTAG ³	Transfer existing registration (must provide tag number)	\$95.00 ¹	\$95.00 ²	\$95.00 ³
Newtg ¹ NEW TAG ² NEWTAG ³	New state tag (specify state, county, city, sheriff, etc.)	\$150.00 ¹	\$150.00 ²	\$175.00 ³
40LMH ¹	Maintenance Plan - specify 48 months 100K miles vehicle warranty excludes engine and transmission. ¹	\$750.00 ¹	NA	NA
40LMT ¹	Maintenance Plan - specify 60 months 100K miles vehicle warranty excludes engine and transmission. ¹	\$830.00 ¹	NA	NA
40LMV ¹	Maintenance Plan - specify 60 months 150K miles vehicle warranty excludes engine and transmission. ¹	\$1,775.00 ¹	NA	NA
40KXJ ¹ 40LMH ² 40LMH ³	Warranty - specify 60 Months 100K mile engine warranty ¹ Navistar: to 48-month /100,000 miles (160,000km) , covers 100% parts and labor, excludes extended warranty for engine and allison transmission ² Extended Vehicle Coverage - 48 Months or 100,000 Miles - excludes engine & transmission ³	\$665.00 ¹	\$750.00 ²	\$752.00 ³
40KXL ¹ 40LMT ² 40LMT ³	Warranty - specify 60 months 150K mile engine warranty ¹ Navistar: to 60-month /100,000 miles (160,000km) , covers 100% parts and labor, excludes extended warranty for engine and allison transmission ² Extended Vehicle Coverage - 60 Months or 150,000 Miles - excludes engine & transmission ³	\$1,050.00 ¹	\$800.00 ²	\$827.00 ³

VEHICLE:	Terrastar			
DEALER:	Maudlin International Trucks, LLC	Maudlin International Trucks, LLC	Sun State International Trucks	Rechtien International Trucks, Inc
ZONE:	Western	Northern	Central	Southern
BASE PRICE:	\$49,166.00	\$48,166.00	\$45,145.00	\$48,505.00

40KXN ¹ 40LMV ² 40LMV ³	Warranty - specify 60 months 200K mile engine warranty ¹ Navistar: to 60-month /150,000 miles (160,000km) , covers 100% parts and labor, excludes extended warranty for engine and allison transmission ² Extended Vehicle Coverage - 60 Months or 150,000 Miles - excludes engine & transmission ³	\$1,925.00 ¹	\$1,800.00 ²	\$1,748.00 ³
40ALL ²	Diesel Warranty - specify Navistar to 60 month /100,000 miles (160,000 km) 3,600 hours ² Engine Sevice Coverage - 48 Months, 100,000 Miles, or 3,600 hours. Includes after-treatment system ³	NA	\$175.00 ²	Std ³
40KXJ ² 40KXJ ³	Diesel Warranty - specify Navistar 60 month / 100,000 miles (160,000 km) 3,600 hours INcludes engine, engine electronics, and injectors for Maxforce 7 engines ² Engine Sevice Coverage - 60 Months, 100,000 Miles, or 3,600 hours. Includes after-treatment system. Includes factory option code 40KVK ³	NA	\$680.00 ²	\$1,504.00 ³
40KXL ² 40KX ³	Diesel Warranty - specify Navistar 60 month / 150,000 miles (160,000 km) 3,600 hours INcludes engine, engine electronics, and injectors for Maxforce 7 engines ² Engine Sevice Coverage - 60 Months, 100,000 Miles, or 5,400 hours. Includes after-treatment system. Includes factory option code 40KVM ³	NA	\$1,000.00 ²	\$1,974.00 ³

February 29, 2016
Our 87th Year

Ship To:
CITY OF HOLLYWOOD
PUBLIC WORKS DEPT
1600 S PARK RD
PO BOX 229045
HOLLYWOOD, FL 33022-9045
US

Bill To:
CITY OF HOLLYWOOD
PUBLIC WORKS DEPT
1600 S PARK RD
PO BOX 229045
HOLLYWOOD, FL 33022-9045
United States

Attn:
Phone:
Email:

Altec Quotation Number: 311264 - 3
Account Manager: Jenny Carlson
Technical Sales & Support: Kasey Ruth Tipton

<u>Item</u>	<u>Description</u>	<u>Qty</u>
	<u>Unit</u>	
1.	ALTEC Model AT40-G telescopic articulating Aerial device with ISO-Boom. <ul style="list-style-type: none"> A. ISO Boom: the inner telescopic fiberglass boom maintains full dielectric integrity even with the fiberglass inner boom fully retracted. B. Hydraulic platform leveling system. C. Hydraulic tool circuit at the platform. D. Emergency lowering valve at the platform. E. Single handle control at the platform with a safety interlock system. F. Two (2) operators and maintenance/parts manuals. G. Working height: 45.6 feet H. Side reach: 29.7 feet I. Low-power fiber-optic control system (FOC-L). J. Continuous rotation 	1
2.	AT40G Unit Model	1
3.	Post style pedestal mounting	1
4.	Poly Reservoir, Pedestal Mounted, 7 Gallon; Includes Sight Gauge.	1
5.	Single One-Man End-Mounted Platform With 180 Degree Rotator, 24 X 30 X 42. Platform is rated at 400 pounds. Control panel on platform dashboard provides controls for auxiliary functions. Includes emergency stop (push-pull) switch and rocker switches, which operate platform leveling, platform rotation, tools, and battery selector (for fiber-optic controls system). Composite fiberglass platform mounting bracket. (AT40G)	1
6.	Platform Leveling At Lower Controls. AT40-G	1
7.	Two (2) Platform Steps	1

We Wish To Thank You For Giving Us The Pleasure
And Opportunity of Serving You

<u>Item</u>	<u>Description</u>	<u>Qty</u>
8.	Soft nylon reinforced vinyl platform cover for a 24 x 30 inch platform	1
9.	Platform liner for a 24 x 30 x 42 inch platform	1
10.	4-Function Single Handle Fiber-Optic Controller.	1
11.	Engine Start/Stop at the upper controls actuated through the Fiber-Optic controls system with Secondary Stowage System (AT40G)	1
12.	Manual lowering valve located at the boomtip. For use in emergency situations to allow the operator to lower the boom to the ground	1
13.	Powder coat unit Altec White.	1

Unit & Hydraulic Acc.

14.	HVI-22 Hydraulic Oil (Standard).	9
15.	Standard Pump For PTO	1
16.	Hot shift PTO for automatic transmission	1

Body

17.	108 Inch Universal Small Aerial Body for a 60 Inch CA Chassis with 38 Inch Long Side Access Tailshelf to Meet the Following Specifications:	1
-----	---	---

- A. Basic body fabricated from A40 grade 100% zinc alloy coated steel
- B. All doors are full, double paneled, self-sealed with built-in drainage.
- C. Electro-zinc plated, steel hinge rods extend full length of door.
- D. Door hinges are zinc alloy material attached with rivets
- E. All doors contain stainless steel, flush mounted, paddle activated rotary style latches with two-stage locking, including keyed locks and adjustable strikers.
- F. Heavy-gauge welded steel frame construction with smooth galvanneal floor.
- G. All edges are either rolled or folded for strength and safety
- H. Door header drip rail at top for maximum weather protection.
- I. Neoprene or rolled fenders on wheel fender panels.
- J. Steel treated for improved primer bond and rust resistance.
- K. Automotive underseal applied to body.
- L. Automotive type non-porous door seals fastened to the door facing.
- M. 108 Inch Body Length
- N. 40 Inch Body Height (Standard)
- O. 94 Inch Body Width (Standard)
- P. 20 Inch Body Compartment Depth (Standard)
- Q. Body Color - White (Standard)
- R. Finish Paint Body At Body Manufacturer (Standard)
- S. 8 Inch Body Cross-members (Standard)
- T. No Treadplate On Compartment Tops
- U. 6 Inch tall wood tailboard installed at the rear of body cargo area
- V. No Compartment Lighting Supplied by the Body Manufacturer
- W. Stainless Steel Rotary Paddle Latch With Lock (Standard)

We Wish To Thank You For Giving Us The Pleasure
And Opportunity of Serving You

<u>Item</u>	<u>Description</u>	<u>Qty</u>
X.	Master Body Locking System (Standard)	
Y.	No Chock Holders In Line Body Fender Panel Required (Standard)	
Z.	Gas Shock Type Rigid Door Holders For Vertical Doors (Standard)	
AA.	Chains On Horizontal Doors	
AB.	Hotstick shelf extending full length of body on curbside.	
AC.	Drop-Down Hot Stick Door For One (1) Shelf (Right Side)	
AD.	Two (2) Hot Stick Brackets	
AE.	1st Vertical Street Side (LH) - Two (2) Adjustable Shelf With Removable Dividers On 4 Inch Centers	
AF.	1st Horizontal Street Side (LH) - One (1) Fixed Shelf With Removable Dividers On 8 Inch Centers	
AG.	Rear Vertical Street Side (LH) - Six (6) Adjustable Locking Swivel Hooks	
AH.	1st Vertical Curb Side (RH) - Seven (7) Adjustable Locking Swivel Hooks, Louvered Panel Installed in Cargo Wall	
AI.	1st Horizontal Curb Side (RH) - Vacant	
AJ.	Rear Vertical Curb Side (RH) - Two (2) Adjustable Shelf With Removable Dividers On 4 Centers	
AK.	Aluminum Rock Guards Installed at Bottom	
AL.	38" Tailshelf with Integrated Side Access Steps, Two Wheel Chock Holders, and Smooth Galvaneal Floor Installed at Rear of Body	

Body and Chassis Accessories

18.	ICC Underride Protection	1
19.	Combination 2 Ball (10,000 LB MGTW) And Pintle Hitch (16,000 LB MGTW)	1
20.	Set Of Eye Bolts for Trailer Safety Chain, installed one each side of towing device mount.	1
21.	Front Torsion Bar Installed On Chassis	1
22.	Rear Torsion Bar Installed On Chassis	1
23.	Appropriate counterweight added for stability.	1
24.	Cable Step Installed At Rear, Single Step	1
25.	Platform Rest, Rigid with Rubber Tube	1
26.	Boom Rest for a Telescopic Unit	1
27.	Mud Flaps With Altec Logo (Pair)	1
28.	Wheel Chocks, Rubber with Metal Hairpin Style Handle, 9.75" L X 7.75" W X 5.00" H (Pair)	1
29.	U-Shaped Grab Handle	1
30.	Small Grab Handle Installed At Rear	1
31.	Slope Indicator Assembly For Machine Without Outriggers	1

We Wish To Thank You For Giving Us The Pleasure
And Opportunity of Serving You

<u>Item</u>	<u>Description</u>	<u>Qty</u>
32.	Safety Harness & 4.5 FT Lanyard (Medium To X-large)	1
33.	5 LB Fire Extinguisher With Light Duty Bracket, Installed Per DEPS 042 (In Cab or Inside Compartment Only)	1
34.	Triangular Reflector Kit, Installed	1
35.	Soft Vinyl Lanyard Pouch	1
36.	Vinyl manual pouch for storage of all operator and parts manuals	1

Electrical Accessories

37.	Lights and reflectors in accordance with FMVSS #108 lighting package. (Complete LED, including LED reverse lights)	1
38.	Altec Standard Amber LED Strobe Light with Brush Guard Post mounted on SS front of body	1
39.	4-Corner Strobe Lighting, Amber LED, Two (2) Oval Lights Mounted in Front Grille and Two (2) Round Lights Mounted at Rear	1
40.	Single tone back up alarm installed between the chassis frame rails at the rear of the chassis. To work in conjunction with chassis reverse drive system	1
41.	6-Way Trailer Receptacle (Pin Type) Installed At Rear	1
42.	Start/Stop/Throttle Module, 12 Volt System	1
43.	Install secondary stowage system.	1

Finishing Details

44.	Altec Standard; Components mounted below frame rail shall be coated black by Altec. i.e. step bumpers, steps, frame extension, pintle hook mount, dock bumper mounts, D-rings, receiver tubes, accessory mounts, light brackets, under-ride protection, etc. Components mounted to under side of body shall be coated black by Altec. i.e. Wheel chock holders, mud flap brackets, pad carriers, boxes, lighting brackets, steps, and ladders.	1
45.	Apply Non-Skid Coating to all walking surfaces	1
46.	English Safety And Instructional Decals	1
47.	Vehicle Height Placard - Installed In Cab	1
48.	Placard, HVI-22 Hydraulic Oil	1
49.	Dielectric test unit according to ANSI requirements.	1
50.	Stability test unit according to ANSI requirements.	1
51.	Focus Factory Build	1

We Wish To Thank You For Giving Us The Pleasure
And Opportunity of Serving You

<u>Item</u>	<u>Description</u>	<u>Qty</u>
52.	Delivery Of Completed Unit	1
53.	Inbound Freight	1
54.	AT40G FA Installation	1
<u>Chassis</u>		
55.	Chassis	1
56.	Customer Supplied Chassis	1
57.	2016 Model Year	1
58.	TerraStar	1
59.	4x2	1
60.	60 Clear CA (Round To Next Whole Number)	1
61.	Regular Cab	1
62.	Chassis Cab	1
63.	Maxxforce 7	1
64.	Allison 1000 RDS Automatic Transmission	1
65.	GVWR 19,000 LBs	1
66.	7,000 LBS Front GAWR	1
67.	13,660 LBS Rear GAWR	1
68.	Hydraulic Brakes	1
69.	Park Brake In Rear Wheels	1
70.	07BDA - International Exhaust (Right-Horizontal-Behind Cab-Horizontal)	1
71.	12VZA - International PTO Throttle Wiring	1
72.	International Heavy Duty Tail Light Wiring (08HAB)	1
73.	No Prewire Chassis	1
74.	No Idle Engine Shut-Down Required	1
75.	No California Emission Requirements	1
76.	15SSW - International 40 Gallon Fuel Tank (Rear, Between Rails)	1
77.	Other Chassis DEF Tank	1
78.	Battery Under Cab Left Hand	1

We Wish To Thank You For Giving Us The Pleasure
And Opportunity of Serving You

<u>Item</u>	<u>Description</u>	<u>Qty</u>
79.	No Air Horn	1
<u>Additional Pricing</u>		
80.	Standard Altec Warranty: One (1) year parts warranty, one (1) year labor warranty, ninety (90) days warranty for travel charges, limited lifetime structural warranty	1

Altec Industries, Inc.

BY _____

Kasey Ruth Tipton

Notes:

- 1 Altec Standard Warranty:
 One (1) year parts warranty.
 One (1) year labor warranty.
 Ninety (90) days warranty for travel charges.
- Warranty on structural integrity of the following major components is to be warranted for so long as the initial purchaser owns the product: Booms, boom articulation links, hydraulic cylinder structures, outrigger weldments, pedestals, subbases and turntables.
- Altec is to supply a self-directed, computer based training (CBT) program. This program will provide basic instruction in the safe operation of this aerial device. This program will also include and explain ANSI and OSHA requirements related to the proper use and operation of this unit.
- Altec offers its standard limited warranty with the Altec supplied components which make up the Altec Unit and its installation, but expressly disclaims any and all warranties, liabilities, and responsibilities, including any implied warranties of fitness for a particular purpose and merchantability, for any customer supplied parts
- Altec designs and manufactures to applicable Federal Motor Vehicle Safety and DOT standards
- 2 Altec takes pride in offering solutions that provide a safer work environment for our customers. In an effort to focus on safety, we would encourage you to consider the following items:
- Outrigger pads (When Applicable)
 - Fall Protection System
 - Fire extinguisher/DOT kit
 - Platform Liner (When Applicable)
 - Altec Sentry Training

We Wish To Thank You For Giving Us The Pleasure
 And Opportunity of Serving You

Wheel Chocks

The aforementioned equipment can be offered in our new equipment quotations. If you find that any of these items have not been listed as priced options in the body of your quotation and are required by your company, we would encourage you to contact your Altec Account Manager and have an updated quotation developed for you. These options must be listed as individual options in the body of the quotation for them to be supplied by Altec.

- 3 Unless otherwise noted, all measurements used in this quote are based on a 40 inch (1016mm) chassis frame height and standard cab height for standard configurations.
- 4 F.O.B. - Customer Site
- 5 Changes made to this order may affect whether or not this vehicle is subject to F.E.T. A review will be made at the time of invoicing and any applicable F.E.T. will be added to the invoice amount.
- 6 Price does not reflect any local, state or Federal Excise Taxes (F.E.T). The quote also does not reflect any local title or licensing fees. All appropriate taxes will be added to the final price in accordance with regulations in effect at time of invoicing.
- 7 Interest charge of 1/2% per month to be added for late payment.
- 8 Delivery: 270-300 days after receipt of order PROVIDING:
A. Order is received within 14 days from the date of the quote. If initial timeframe expires, please contact your Altec representative for an updated delivery commitment.
B. Chassis is received a minimum of sixty (60) days before scheduled delivery.
C. Customer approval drawings are returned by requested date.
D. Customer supplied accessories are received by date necessary for compliance with scheduled delivery.
E. Customer expectations are accurately captured prior to releasing the order. Unexpected additions or changes made at a customer inspection will delay the delivery of the vehicle.

Altec reserves the right to change suppliers in order to meet customer delivery requirements, unless specifically identified, by the customer, during the quote and or ordering process.

- 9 Trade-in offer is contingent upon equipment being maintained to DOT (Department of Transportation) operating and safety standards. This will include, but not limited to tires, lights, brakes, glass, etc. If a trade-in is not maintained to DOT standards, additional transportation expenses will apply and could be invoiced separately.

All equipment, i.e., jibs, winches, pintle hooks, trailer connectors, etc., are to remain with the vehicle unless otherwise agreed upon in writing by both parties. Altec Industries reserves the right to re-negotiate its trade-in offer if these conditions are not met.

Customer may exercise the option to rescind this agreement in writing within sixty (60) days after receipt of purchase order. After that time Altec Industries will expect receipt of trade-in vehicle upon delivery of new equipment as part of the terms of the purchase order.

Titles for trade-in equipment should be given to the appropriate Altec Sales associate or forwarded to Altec Nueco at address 1730 Vanderbilt Road, Birmingham, AL 35234.

- 10 This quotation is valid until APR 04, 2016. After this date, please contact Altec Industries, Inc. for a possible extension.
- 11 After the initial warranty period, Altec Industries, Inc. offers mobile service units, in-shop service and same

day parts shipments on most parts from service locations nationwide at an additional competitive labor and parts rate. Call 877-GO-ALTEC for all of your Parts and Service needs.

12 Please email Altec Capital at finance@altec.com or call 888-408-8148 for a lease quote today.

13 Please direct all questions to Jenny Carlson at (270) 360-0600

Prepared For:
City of Hollywood
Joel Wall
2600 Hollywood Blvd.
Hollywood, FL 33020-4800
(954)921 - 3290
Reference ID: #9 - 19500

Presented By:
RECHTIEN INTERNATIONAL TRUCKS, INC.
John W Bradley
3787 INTERSTATE PARK ROAD
RIVIERA BEACH FL 33404 -
(866)882-9050

Thank you for the opportunity to provide you with the following quotation on a new International truck. I am sure the following detailed specification will meet your operational requirements, and I look forward to serving your business needs.

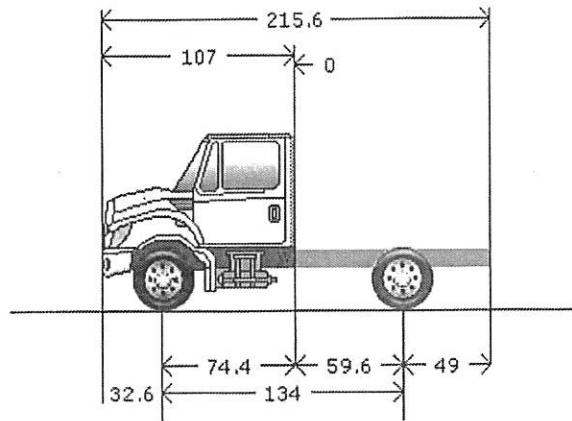

Model Profile
2017 TERRASTAR SFA 4x2 (TA005)

APPLICATION:	Stake Flat
MISSION:	Requested GVWR: 19500. Calc. GVWR: 19500
DIMENSION:	Wheelbase: 134.00, CA: 59.60, Axle to Frame: 49.00
ENGINE, DIESEL:	{MaxxForce 7} EPA 2010, 300 HP @ 2600 RPM, 660 lb-ft Torque @ 1600 RPM, 2800 RPM Governed Speed, 300 Peak HP (Max)
TRANSMISSION, AUTOMATIC:	{Allison 1000_RDS} 5th Generation Controls; Close Ratio, 5-Speed, With Overdrive; Includes Park Pawl, With PTO Provision, Less Retarder, With 19,500-lb GVW & 26,000-lb GCW Max., on/off hwy
CLUTCH:	Omit Item (Clutch & Control)
AXLE, FRONT NON-DRIVING:	{Dana Spicer D700-N} I-Beam Type, 7,000-lb Capacity
AXLE, REAR, SINGLE:	{Dana Spicer S110} Single Reduction, With Offset Housing; 13,500-lb Capacity, 160 Wheel Ends Gear Ratio: 4.30
CAB:	Conventional
TIRE, FRONT:	(2) 225/70R19.5 HSR-1 (CONTINENTAL) 649 rev/mile, load range G, 14 ply
TIRE, REAR:	(4) 225/70R19.5 HSR-1 (CONTINENTAL) 649 rev/mile, load range G, 14 ply
SUSPENSION, RR, SPRING, SINGLE:	Vari-Rate; 13,500-lb Capacity
PAINT:	Cab schematic 100TA Location 1: 9219, Winter White (Std) Chassis schematic N/A



FOR NEW EQUIPMENT SALES, CALL
800.958.2555
TO SPEAK WITH AN ALTEC REPRESENTATIVE
or visit us online at altec.com

 **Altec**
TELESCOPIC ARTICULATING
AERIAL DEVICE

FEATURES

- Telescopic Articulating Aerial Device
- Compensated Articulating Arm
- Hydraulic Boom Extension
- Altec ISO-Grip® Control System
- Low Power Fiber Optic Control System
- Fully Metered 4-Function, Single-Handle Upper Control
- Platform Access from Ground
- Composite Platform Mounting Bracket
- Insulating, ANSI Category C
- Hydraulic Platform Leveling System
- Emergency Lowering Valve at Platform
- Platform Leveling at Upper and Lower Controls
- 180° Platform Rotator
- Tool Circuit at Platform
- Open-Center Hydraulic System
- Easily Mounted on 19,500 lb (8,845 kg) GVWR Chassis
- Outrigger Boom Interlock System (with Outrigger Option)
- Outrigger Motion Alarm (with Outrigger Option)
- Back Up Alarm

OPTIONS

- ISO-Boom Offering ANSI Category C Isolation with Boom Retracted
- Outriggers, Vertical
- Hybrid Adaptation Available with Standard Electronic Systems
- Secondary Stowage
- Engine Start/Stop
- Platform Cover
- Tool Circuit at Tailshelf
- 24 x 24 x 42 in (610 x 610 x 1067 mm) Platform

Recommended safety equipment, available through Altec Supply, include a platform liner, fall protection system, wheel chocks and outrigger pads (with outrigger option).

SPECIFICATIONS

Ground to Bottom of Platform* (at Reach from Centerline)	40.6 ft (12.4 m) 10.9 ft (3.3 m)
Working Height	45.6 ft (13.9 m)
Maximum Side Reach (at Platform Height)	29.7 ft (9.1 m) 15.2 ft (4.6 m)
Platform Capacity	400 lb (181.4 kg)
Platform Dimensions (End-Mount)	24 x 30 x 42 in (610 x 762 x 1,067 mm)
Articulating Arm Articulation	-5 to 79°
Upper Boom Articulation	-25 to 75°
Stowed Travel Height	10.3 ft (3.1 m)
Rotation	Continuous
Weight of Machine**	2,543 lb (1,153 kg)

*Based on a 40 in (1016 mm) chassis frame height.
** Weight does not include mounting frame or outriggers.

REACH DIAGRAM

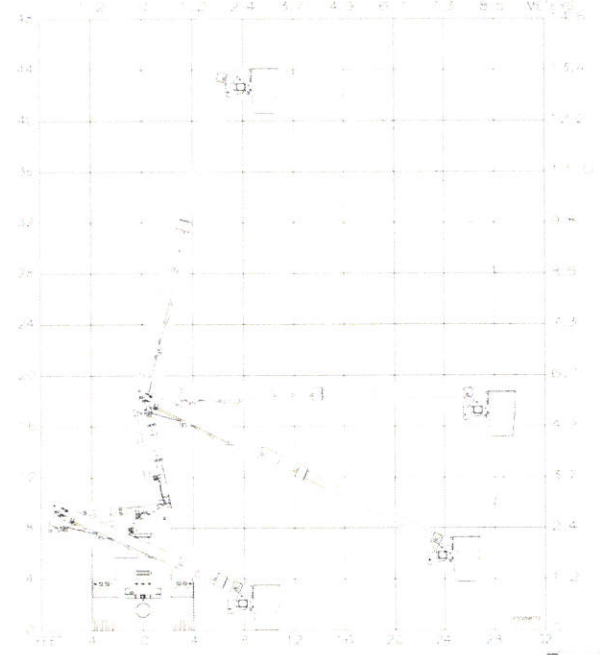

INCREASED SIDE REACH 29.7 FT (9.1 M)



INCREASED WORKING HEIGHT 45.6 FT (13.9 M)



ISO-BOOM OPTION FOR ADDED DIELECTRIC INTEGRITY



FIBER OPTIC CONTROLS WITH FEWER HOSES AND VALVES

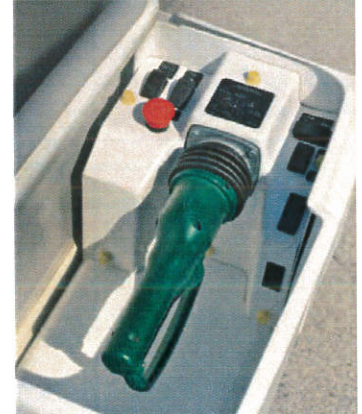

For more complete information on Altec products and services, visit us on the web at www.altec.com. Material and specifications are subject to change without notice. Featured units in photos may include optional features. Please contact an Altec representative for all available options. Altec® and the Altec logo are registered trademarks of Altec Inc. in the United States and various other countries and may not be used without permission.
© 2015 Altec Inc. All Rights Reserved. AIOSAT40G-0315 v1



FOR NEW EQUIPMENT SALES, CALL
800.958.2555
TO SPEAK WITH AN ALTEC REPRESENTATIVE
or visit us online at altec.com

 **Altec**
TELESCOPIC ARTICULATING
AERIAL DEVICE

FEATURES

- Telescopic Articulating Aerial Device
- Compensated Articulating Arm
- Hydraulic Boom Extension
- Altec ISO-Grip® Control System
- Low Power Fiber Optic Control System
- Fully Metered 4-Function, Single-Handle Upper Control
- Platform Access from Ground
- Composite Platform Mounting Bracket
- Insulating, ANSI Category C
- Hydraulic Platform Leveling System
- Emergency Lowering Valve at Platform
- Platform Leveling at Upper and Lower Controls
- 180° Platform Rotator
- Tool Circuit at Platform
- Open-Center Hydraulic System
- Easily Mounted on 19,500 lb (8,845 kg) GVWR Chassis
- Outrigger Boom Interlock System (with Outrigger Option)
- Outrigger Motion Alarm (with Outrigger Option)
- Back Up Alarm

OPTIONS

- ISO-Boom Offering ANSI Category C Isolation with Boom Retracted
- Outriggers, Vertical
- Hybrid Adaptation Available with Standard Electronic Systems
- Secondary Stowage
- Engine Start/Stop
- Platform Cover
- Tool Circuit at Tailshelf
- 24 x 24 x 42 in (610 x 610 x 1067 mm) Platform

Recommended safety equipment, available through Altec Supply, include a platform liner, fall protection system, wheel chocks and outrigger pads (with outrigger option).

Ground to Bottom of Platform* (at Reach from Centerline)	40.6 ft (12.4 m) 10.9 ft (3.3 m)
Working Height	45.6 ft (13.9 m)
Maximum Side Reach (at Platform Height)	29.7 ft (9.1 m) 15.2 ft (4.6 m)
Platform Capacity	400 lb (181.4 kg)
Platform Dimensions (End-Mount)	24 x 30 x 42 in (610 x 762 x 1,067 mm)
Articulating Arm Articulation	-5 to 79°
Upper Boom Articulation	-25 to 75°
Stowed Travel Height	10.3 ft (3.1 m)
Rotation	Continuous
Weight of Machine**	2,543 lb (1,153 kg)

*Based on a 40 in (1016 mm) chassis frame height.
** Weight does not include mounting frame or outriggers.

REACH DIAGRAM

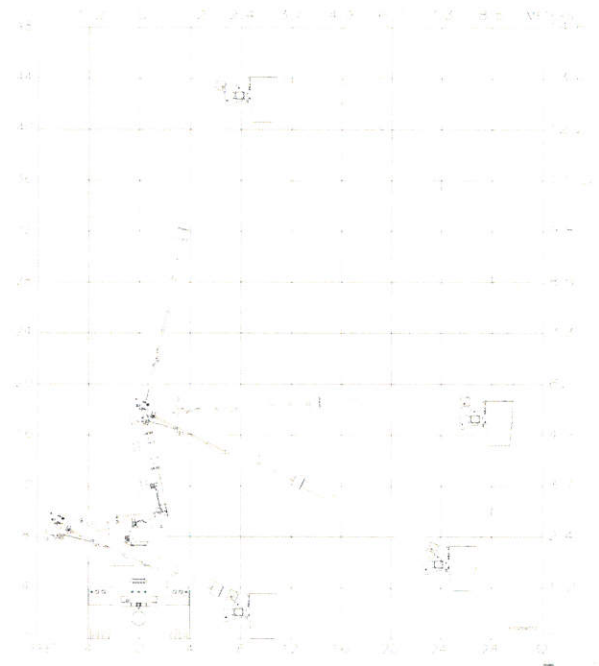

INCREASED SIDE REACH 29.7 FT (9.1 M)



INCREASED WORKING HEIGHT 45.6 FT (13.9 M)



ISO-BOOM OPTION FOR ADDED DIELECTRIC INTEGRITY



FIBER OPTIC CONTROLS WITH FEWER HOSES AND VALVES



For more complete information on Altec products and services, visit us on the web at www.altec.com. Material and specifications are subject to change without notice. Featured units in photos may include optional features. Please contact an Altec representative for all available options. Altec® and the Altec logo are registered trademarks of Altec Inc. in the United States and various other countries and may not be used without permission.
© 2015 Altec Inc. All Rights Reserved. AIOSAT40G-0315-v1

